



MODEL :BRTC8D180

# TOOL CABINET

## 7 + 1 DRAWERS

### 180 TOOLS (EVA TRAYS)



**\*OPTIONAL ITEM\***  
HANGING METAL  
DUSTBIN

BALL BEARING  
SLIDE DRAWERS

+  
UNIVERSAL  
PERFORATION  
SIDE HANGING

STAINLESS STEEL  
HAIRLINES TOP  
TABLE COVER

**\*FREE LIMITED\***  
1PC EVA SHEET FOR TOP

765\*460\*975MM

7+1 ADDITIONAL SIDE  
DRAWER WITH  
HANGING HOLES



2X   
DRAWERS  
CENTRAL LOCK

  
MAX LOAD PER  
DRAWER : 35KG

2X   
BRAKE WHEEL

## 5 EVA TRAYS : 180 TOOLS

### 2 VACANT TRAYS WITH EVA SHEET



**\*\*ITEMS DISPLAYED AT THE SIDE DRAWER AND ALL THE ABOVE FOR ILLUSTRATION PURPOSE ONLY\*\***



# PRODUCT DETAILS

## FEATURES



- **BIGRED** BRANDED TOOL CABINET WITH TOOLS
- THE TOOL CABINET CONSISTS OF: **7 + 1 DRAWERS**
  - **5 TRAYS (HORIZONTAL)** : TOTAL **180PCS** TOOLS WITH EVA TRAYS
  - **2 TRAYS (HORIZONTAL)** : VACANT WITH EVA FOAM SHEET
  - **1 TRAY (SIDE VERTICAL)** : VACANT WITH LOCK AND HANGING HOLES
- DRAWERS ON **BALL BEARING SLIDE GUIDES** WITH METAL BLACK HANDLE  
\*ADDITIONAL GRIP CLOSURE FOR 7 HORIZONTAL DRAWERS WITH PRESSING THE HANDLE\*
- **2PCS KEY**: CENTRAL LOCK AND CLOSURE FOR HORIZONTAL AND VERTICAL SIDE DRAWERS
- THE TABLETOP OF CABINET IS **STAINLESS STEEL HAIRLINE** DISPLAYS HIGH QUALITY AND DECENT OUTLOOK
- **MAX LOAD PER DRAWER IS 35KG** (TOTAL FOR 8 DRAWERS = 280KG)
- **DURABLE AND STRONG** 4 CASTERS MADE OF PP AND PVC WHICH IS ANTI-RUST AND ANTI-CORROSION  
\*2PCS WITH BRAKE FOR SAFETY AND STAGNANT PLACEMENT\*
- **UNIVERSAL PERFORATED SIDE WALL** (EXTERNAL) FOR HANGING PURPOSE  
\*OPTIONAL ITEM: METAL DUSTBIN\*
  - **SIDE HORIZONTAL DRAWER** : FOR **VABLUAABLE** HANGING TOOLS OR MACHINE TO LOCK OFF FOR SAFETY.



SIDE VERTICAL DRAWER  
UNIVERSAL PERFORATED  
- LOCK FOR VALUABLE



STAINLESS STEEL  
HAIRLINES TOP TABLE  
COVER



4 CASTERS (2-BRAKE)  
PP & PVC MATERIAL MADE  
(STRONG & DURABLE)



# 5 TRAYS >> 180PCS TOOL WITH EVA TRAYS

## TRAY 1 : 30PCS consists of

**22pcs** 6-32MM RATCHET COMBINATION WRENCHES

(6/ 7/ 8/ 9/ 10/ 11/ 12/ 13/ 14/ 15/ 16/ 17/ 18/ 19/ 20/ 21/  
22/ 23/ 24/ 27/ 30/ 32)

**8pcs** 6-22MM DOUBLE RING WRENCHES

(6x7/ 8x9/ 10x11/ 12x13/ 14x15/ 16x17/ 18x19/ 20x22)



## TRAY 2: 32PCS consists of

**12pcs** SCREWDRIVERS

(+) PH0\*75, PH1\*100, PH2\*38, PH2\*100, PH2\*150, PH3\*200MM

(-) 6\*38, 3\*75, 4\*100, 5\*100, 6\*150, 8\*200MM

**6pcs** HIGH PRESSURE SCREWDRIVER (RED COLOUR)

(+) 0\*75, 1\*100, 2\*100MM; (-) 3\*75, 4\*100, 5\*125MM

**8pcs** HEX KEY WRENCHES (\*) T9, T10, T15, T20, T25, T27, T30, T40MM

**6pcs** PRECISION SCREWDRIVERS (+) 0 - 1 - 2; (-) 1 - 2 - 3



## TRAY 3: 9PCS consists of

**4pcs** FRENCH CIRCLIP PLIERS

**5pcs** PLIERS

(8" LINESMAN PLIER, 8" LONG NOSE PLIER, 7" DIAGONAL CUTTING PLIER, 10" LOCKING PLIER, D4 WATER PUMP PLIER)



## TRAY 4: 60PCS consist of

**3pcs** RATCHET HANDLE

(1/2" 72T; 3/8" 72T; 1/4" 72T (1/4\*6" HANDLE))

**17pcs** 1/2 DR SOCKET (MM)

(10, 11, 12, 13, 14, 15, 16, 17, 18, 19, 21, 22, 23, 24, 27, 30, 32)

**15pcs** 3/8 DR SOCKET (MM)

(8, 9, 10, 11, 12, 13, 14, 15, 16, 17, 18, 19, 21, 22, 24)

**13pcs** 1/4 DR SOCKET (MM)

(4, 4.5, 5, 5.5, 6, 7, 8, 9, 10, 11, 12, 13, 14)

**6pcs** EXTENSION BAR

(1/2 DR\*5", 1/2 DR\*10", 3/8 DR\*3", 3/8 DR\*6", 1/4 DR\*2", 1/4 DR\*4")

**3pcs** SLIDING T-BAR (1/2, 3/8, 1/4)

**3pcs** UNIVERSAL JOINT (1/2, 3/8, 1/4)



## TRAY 5: 49PCS consist of

**9pcs** HEX KEY WRENCHES (1.5, 2, 2.5, 3, 4, 5, 6, 8, 10 (MM)

**9pcs** 1/4" SOCKET LONG (4, 5, 6, 7, 8, 9, 10, 11, 12)

**23pcs** 1/4" PRESS FIT SOCKET (T8, T10, T15, T20, T25, T30, T40, H3, H4, H5, H6, H7, H8, PH1, PH2, PH3, PZ1, PZ2, PZ3, SL3, SL4, SL5, SL6)







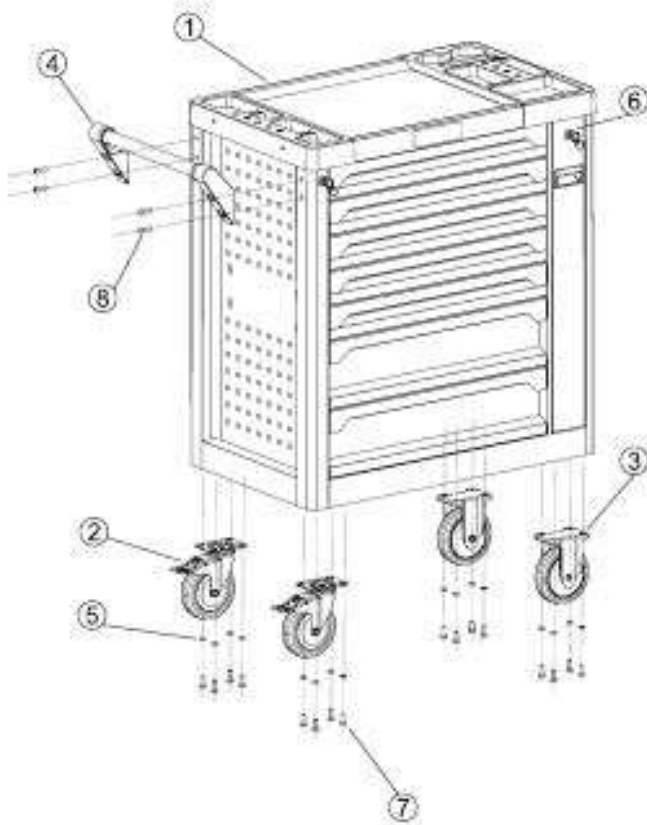

**2pcs** HAMMER (Plastic, German type)

**6pcs** BALLPOINT HEX. T-HANDLE SCREWDRIVERS



## Install wheels and handles



TEKL.	NR.	STK.
	①	1 PCS
	②	2 PCS
	③	2 PCS
	④	1 PCS
	⑤	16 PCS
 Key	⑥	2 PCS
 M8*20	⑦	16 PCS
Hand screw  M8*25	⑧	4 PCS



[www.bigred.my](http://www.bigred.my)

**THANK YOU FOR YOUR SUPPORT !!!**